

**CADENAS
TRANSPORTADORAS**

CONVEYOR CHAINS

CHAÎNES DE MANUTENTION



CADENAS TRANSPORTADORAS

CONVEYOR CHAINS

CHAÎNES DE MANUTENTION

M / MT / MC Serie <i>Series / Série</i>	01
FV / FVT / FVC Serie <i>Series / Série</i>	05
Y / YT / YC Serie <i>Series / Série</i>	09
No estándar <i>Non standard / Non standard</i>	12
No estándar de acero inoxidable <i>Non standard stainless steel / Non standard acier inox</i>	17
Casquillo fijo <i>Bush chains / Chaînes à douilles</i>	20
Tipo redler <i>Scraper chains / Chaînes à racloirs</i>	21
Cadenas de eslabones forjados <i>Forged link chains/ Chaînes forgées</i>	22
Cadenas galle <i>Gall chains / Chaînes galle</i>	23
Cadenas de eslabones acodados <i>Offset link chains/ Chaînes à maillons coudés</i>	24
Cadenas aéreas <i>Aerial chains / Chaînes aériennes</i>	25

CADENAS TRANSPORTADORAS SERIE M

Conveyor chains M series

Chaînes de manutention série M

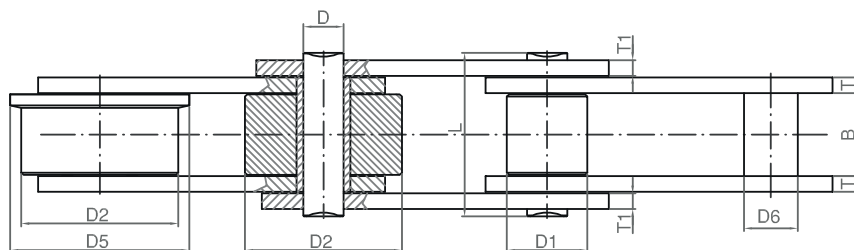
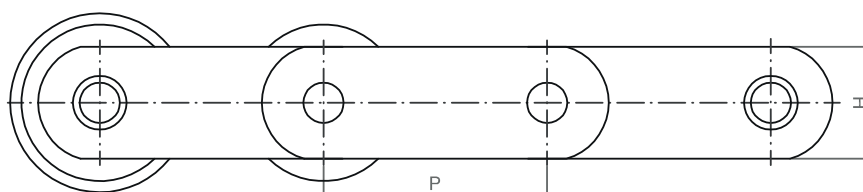

Referencia Reference Référence	Pasos estándar Standard pitches Pas standard						Ancho interior Inner width Largeur intérieure	Ø Casquillo Bush Douille	Ø Rodillos Rollers Roulements			Mallas Plates Maillons		Eje Pin Axe		Carga de rotura Breaking load Charge rupture
									Pequeño Small Petit	Grande Big Grand	Pestaña Flange Épaulé	Ancho Width Largeur	Espesor Thickness Épaisseur	Ø	Longitud Length Longueur	
ISO	P*						B min	D6	D1	D2	D5	H	T/T1	D	L max	Q min
	mm						mm	mm	mm	mm	mm	mm	mm	mm	mm	mm
M-20	40	50	63	80	100	125	16	9	12,5	25	30	18	2,5	6	31	20
M-28	50	63	80	100	125	160	18	10	15	30	36	20	3	7	35	28
M-40	63	80	100	125	160	200	20	12,5	18	36	42	25	4/3	8,5	41	40
M-56	63	80	100	125	160	200	24	15	21	42	50	30	4	10	46	56
M-80	80	100	125	160	200	250	28	18	25	50	60	35	5	12	55	80
M-112	80	100	125	160	200	250	32	21	30	60	70	40	6	15	64	112
M-160	100	125	160	200	250	315	37	25	36	70	85	50	7	18	74	160
M-224	125	160	200	250	315	400	43	30	42	85	100	60	8	21	85	224
M-315	160	200	250	315	400	500	48	36	50	100	120	70	10	25	100	315
M-450	200	250	315	400	500	630	56	42	60	120	140	80	12	30	118	450
M-630	250	315	400	500	630	800	66	50	70	140	170	100	15	36	138	630
M-900	250	315	400	500	630	800	78	60	85	170	210	120	15	44	160	900

* Otros pasos disponibles sobre pedido / Other pitches upon request / Pas différents sur demande

CADENAS TRANSPORTADORAS CON ALETAS SERIE M

Conveyor chains with attachments M series

Chaînes de manutention avec équerres série M

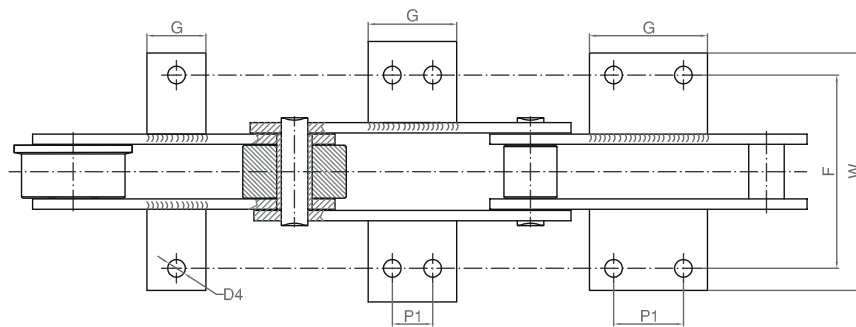
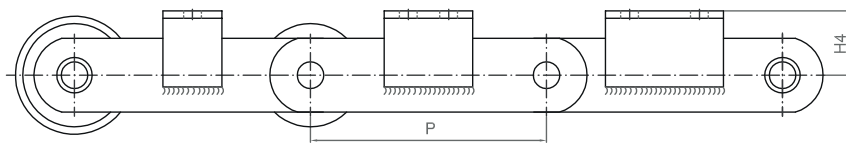

Referencia Reference Référence	Altura aleta Attachment height Hauteur équerre	Distancia entre taladros Distance between holes Distance entre trous	Ancho Width Largeur	Ø Taladro Hole Trou	1 Taladro 1 Hole 1 Trou		2 Taladros 2 Holes 2 Trou									Ángulo Angle Angle
							Corta Short Court			Normal			Larga Long Longue			
	H4	F	W max	D4	P min	G	P min	P1	G	P min	P1	G	P min	P1	G	
ISO	mm	mm	mm	mm	mm	mm	mm	mm	mm	mm	mm	mm	mm	mm	mm	
M-20	16	54	78	6,6	40	14	63	20	35	80	35	50	100	50	65	L25x3
M-28	20	64	92	9	50	20	80	20	45	100	40	60	125	65	85	L30x3
M-40	25	70	116	9	63	20	80	20	40	100	40	60	125	65	85	L40x4
M-56	30	88	125	11	63	22	100	25	50	125	50	75	160	85	110	L40x4
M-80	35	96	140	11	80	22	125	50	75	160	85	110	200	125	150	L45x4
M-112	40	110	160	14	80	28	125	35	65	160	65	95	200	100	130	L50x5
M-160	45	124	190	14	100	30	160	50	80	200	85	115	250	145	175	L60x6
M-224	55	140	220	18	125	35	200	65	100	250	125	160	315	190	225	L70x7
M-315	65	160	255	18	160	35	200	50	85	250	100	135	315	155	190	L80x8
M-450	75	180	310	18	200	40	250	85	125	315	155	195	400	240	280	L100x10
M-630	90	230	370	24	250	50	315	100	150	400	190	240	500	300	350	L120x12
M-900	110	280	440	30	250	60	315	65	125	400	155	215	500	240	300	L150x15

CADENAS TRANSPORTADORAS SERIE MT

Conveyor chains MT series

Chaînes de manutention série MT

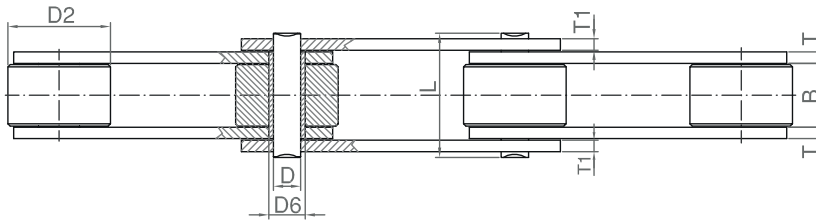
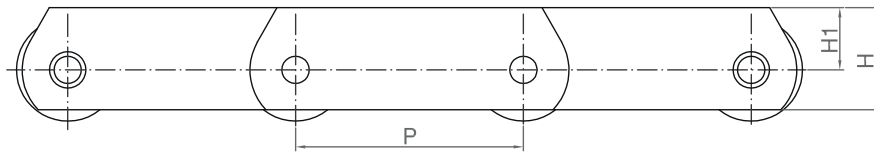

Referencia Reference Référence	Pasos estándar Standard pitches Pas standard							Ancho interior Inner width Largeur intérieure	Ø Casquillo Bush Douille	Ø Rodillos Rollers Rouleaux	Mallas Plates Maillons			Eje Pin Axe		Carga de rotura Breaking load Charge rupture	
	P*										Ancho Width Largeur	Altura Depth Hauteur	Espesor Thickness Épaisseur	Ø	Longitud Length Longueur		
ISO	mm							mm	mm	mm	mm	mm	mm	mm	mm	mm	KN
MT-20	40	50	63	80	100	125	160	16	9	25	25	16	2,5	6	31	20	
MT-28	50	63	80	100	125	160	200	18	10	30	30	20	3	7	35	28	
MT-40	63	80	100	125	160	200	250	20	12,5	36	35	22,5	4/3	8,5	41	40	
MT-56	63	80	100	125	160	200	250	24	15	42	45	30	4	10	46	56	
MT-80	80	100	125	160	200	250	315	28	18	50	50	32,5	5	12	55	80	
MT-112	80	100	125	160	200	250	315	32	21	60	60	40	6	15	64	112	
MT-160	100	125	160	200	250	315	400	37	25	70	70	45	7	18	74	160	
MT-224	125	160	200	250	315	400	500	43	30	85	90	60	8	21	85	224	
MT-315	160	200	250	315	400	500	630	48	36	100	100	65	10	25	100	315	
MT-450		200	250	315	400	500	630	56	42	120	120	80	12	30	118	450	
MT-630		200	250	315	400	500	630	66	50	140	140	90	15	36	138	630	
MT-900			250	315	400	500	630	78	60	170	180	120	15	44	160	900	

* Otros pasos disponibles sobre pedido / Other pitches upon request / Pas différents sur demande

CADENAS TRANSPORTADORAS SERIE MC

Conveyor chains MC series

Chaînes de manutention série MC

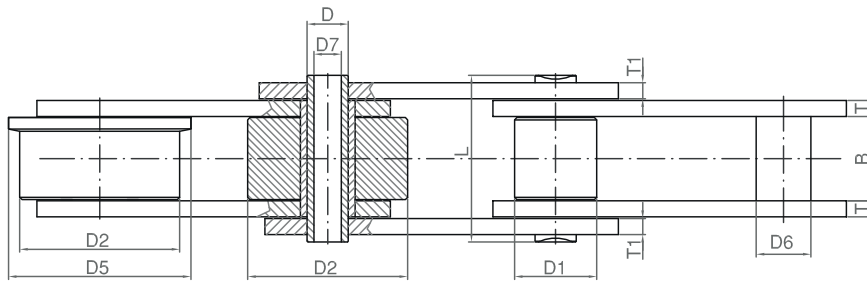
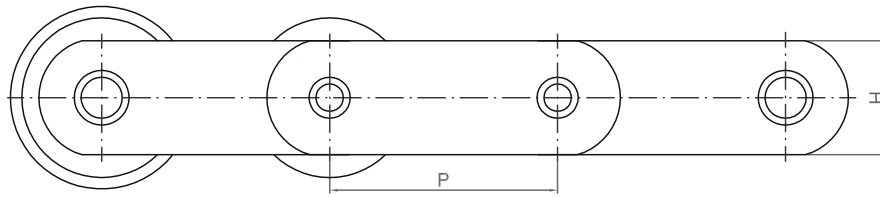

Referencia Reference Référence	Pasos estándar Standard pitches Pas standard					Ancho interior Inner width Largeur intérieure	Ø Casquillo Bush Douille	Ø Rodillos Rollers Rouleaux			Mallas Plates Maillons		Eje Pin Axe			Carga de rotura Breaking load Charge rupture
								Pequeño Small Petit	Grande Big Grand	Pestaña Flange Épaulé	Ancho Width Largeur	Espesor Thickness Épaisseur	Ø Exterior Outer Extérieur	Ø Interior Inner Intérieur	Longitud Length Longueur	
ISO	P*					B min	D6	D1	D2	D5	H	T/T1	D	D7 min	L max	Q min
	mm					mm	mm	mm	mm	mm	mm	mm	mm	mm	mm	KN
MC-28	63	80	100	125	160	20	16	25	36	42	25	4/3	12	8,2	42	28
MC-56	80	100	125	160	200	24	20	30	50	60	35	4	16	10,2	46,5	56
MC-112	100	125	160	200	250	32	30	42	70	85	50	6	22	14,3	64	112
MC-224	160	200	250	315	400	43	42	60	100	120	70	8	30	20,3	85	224

* Otros pasos disponibles sobre pedido / Other pitches upon request / Pas différents sur demande

CADENAS TRANSPORTADORAS SERIE FV

Conveyor chains FV series

Chaînes de manutention série FV

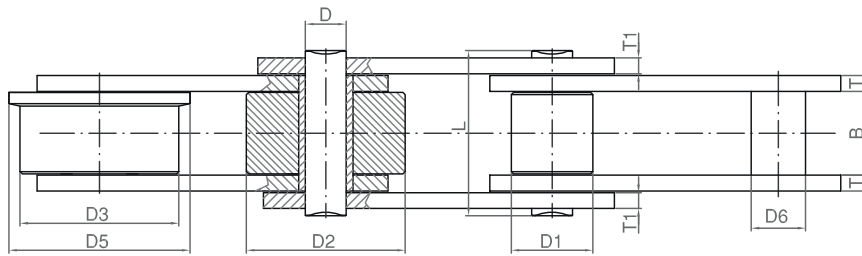
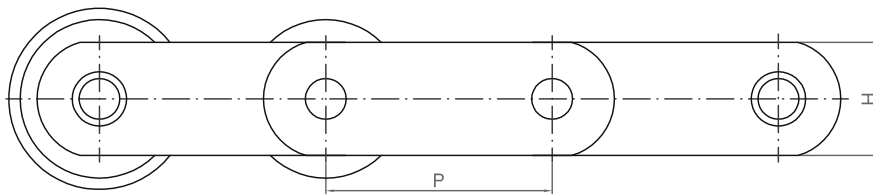

Referencia Reference Référence	Pasos estándar Standard pitches Pas standard						Ancho interior Inner width Largeur intérieure	Ø Casquillo Bush Douille	Ø Rodillos Rollers Rouleaux				Mallas Plates Mailloons		Eje Pin Axe		Carga de rotura Breaking load Charge rupture
									Pequeño Small Petit	Grande Big Grand	Rodadura Rolling Rouleau	Pestaña Flange Epaulé	Ancho Width Largeur	Espesor Thickness Épaisseur	Ø	Longitud Length Longueur	
ISO	P*						B min	D6	D1	D2	D3	D5	H	T/T1	D	L max	Q min
	mm						mm	mm	mm	mm	mm	mm	mm	mm	mm	mm	KN
FV-40	40	63	80	100			18	15	20	32	40	48	25	3	10	37	40
FV-63	40	63	80	100	125	160	22	18	26	40	50	60	30	4	12	46	63
FV-90	63	80	100	125	160	200	25	20	30	48	63	73	35	5	14	53	90
FV-112	80	100	125	160	200	250	30	22	32	55	72	87	40	6	16	63	112
FV-140	100	125	160	200	250	315	35	26	36	60	80	95	45	6	18	68	140
FV-180	125	160	200	250	315	400	45	30	42	70	100	120	50	8	20	86	180
FV-250	125	160	200	250	315	400	55	36	50	80	125	145	60	8	26	98	250
FV-315		160	200	250	315	400	65	42	60	90	140	170	70	10	30	117	315
FV-400		160	200	250	315	400	70	45	60	100	150	185	70	12	32	131	400
FV-500		160	200	250	315	400	80	50	70	110	160	195	80	12	36	141	500
FV-630			160	200	315	400	90	56	80	120	170	210	100	12	42	153	630

* Otros pasos disponibles sobre pedido / Other pitches upon request / Pas différents sur demande

CADENAS TRANSPORTADORAS SERIE FVT

Conveyor chains FVT series

Chaînes de manutention série FVT

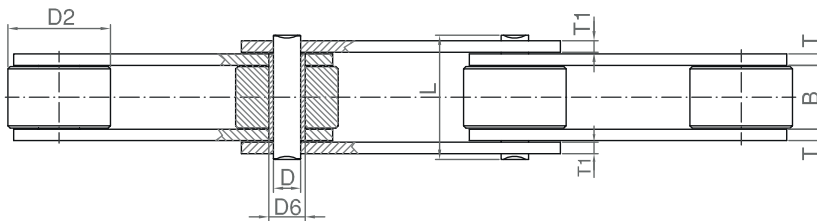
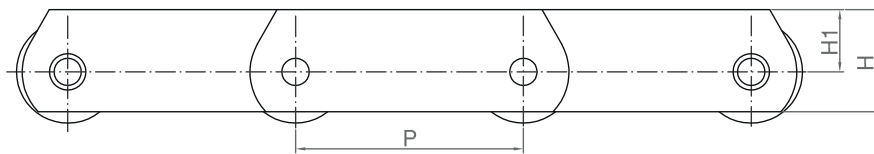

Referencia Reference Référence	Pasos estándar Standard pitches Pas standard						Ancho interior Inner width Largeur intérieure	Ø Casquillo Bush Douille	Ø Rodillos Rollers Rouleaux	Mallas Plates Maillons			Eje Pin Axe		Carga de rotura Breaking load Charge rupture
										Ancho Width Largeur	Altura Depth Hauteur	Espesor Thickness Épaisseur	Ø	Longitud Length Longueur	
ISO	P*						B min	D6	D2	H	H1	T/T1	D	L max	Q min
	mm						mm	mm	mm	mm	mm	mm		mm	KN
FVT-40	40	63	80	100			18	15	32	35	22	3	10	37	40
FVT-63	40	63	80	100	125	160	22	18	40	40	25	4	12	46	63
FVT-90	63	80	100	125	160	200	25	20	48	45	27,5	5	14	53	90
FVT-112	80	100	125	160	200	250	30	22	55	50	30	6	16	63	112
FVT-140	100	125	160	200	250	315	35	26	60	60	37,5	6	18	68	140
FVT-180	125	160	200	250	315	400	45	30	70	70	45	8	20	86	180
FVT-250	125	160	200	250	315	400	55	36	80	80	50	8	26	98	250
FVT-315		160	200	250	315	400	65	42	90	90	55	10	30	117	315
FVT-400		160	200	250	315	400	70	45	100	90	55	12	32	131	400
FVT-500		160	200	250	315	400	80	50	110	100	60	12	36	141	500
FVT-630			160	200	315	400	90	56	120	120	70	12	42	153	630

* Otros pasos disponibles sobre pedido / Other pitches upon request / Pas différents sur demande

CADENAS TRANSPORTADORAS SERIE FVC

Conveyor chains FVC series

Chaînes de manutention série FVC

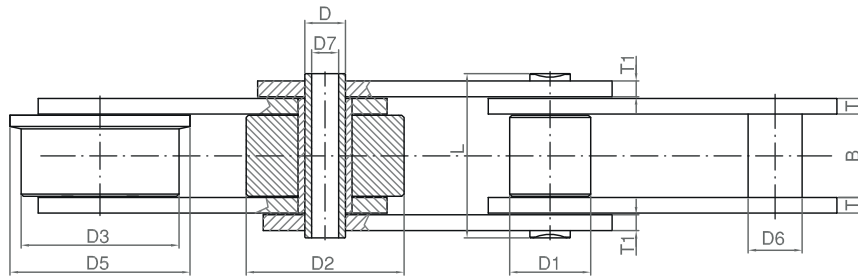
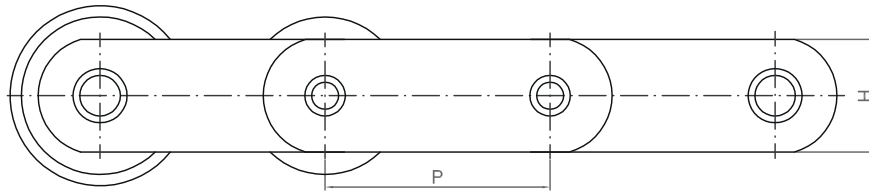

Referencia Reference Référence	Pasos estándar Standard pitches Pas standard						Ancho interior Inner width Largeur intérieur	Ø Casquillo Bush Douille	Ø Rodillos Rollers Rouleaux				Mallas Plates Maillons		Eje Pin Axe			Carga de rotura Breaking load Charge rupture
									Pequeño Small Petit	Grande Big Grand	Rodadura Rolling Rouleau	Pestaña Flange Epaulé	Ancho Width Largeur	Espesor Thickness Épaisseur	Ø Exterior Outer Extérieur	Ø Interior Inner Intérieur	Longitud Length Longueur	
ISO	P*						B min	D6	D1	D2	D3	D5	H	T/T1	D	D7 min	L max	Q min
	mm						mm	mm	mm	mm	mm	mm	mm	mm	mm	mm	mm	KN
FVC-63	40	63	80	100	125	160	22	18	26	40	50	60	30	4	12	8,2	46	57
FVC-90	63	80	100	125	160	200	25	20	30	48	63	73	35	5	14	10,2	53	73
FVC-112	80	100	125	160	200	250	30	22	32	55	72	87	40	6	16	11,2	63	102
FVC-140	100	125	160	200	250	315	35	26	36	60	80	95	45	6	18	12,2	68	136
FVC-180	125	160	200	250	315	400	45	30	42	70	100	120	50	8	20	14,3	86	154
FVC-250	125	160	200	250	315	400	55	36	50	80	125	145	60	8	26	18,3	98	230
FVC-315		160	200	250	315	400	65	42	60	90	140	170	70	10	30	20,3	117	336

* Otros pasos disponibles sobre pedido / Other pitches upon request / Pas différents sur demande

CADENAS TRANSPORTADORAS SERIE Y

Conveyor chains Y series

Chaînes de manutention série Y

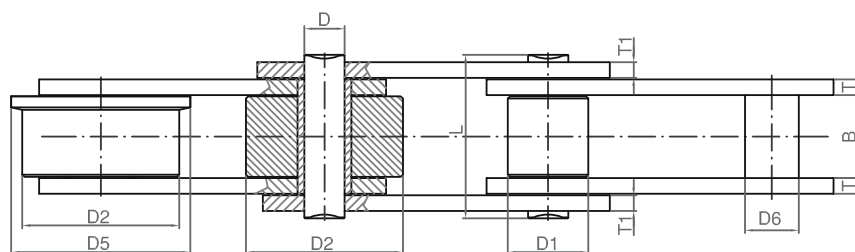
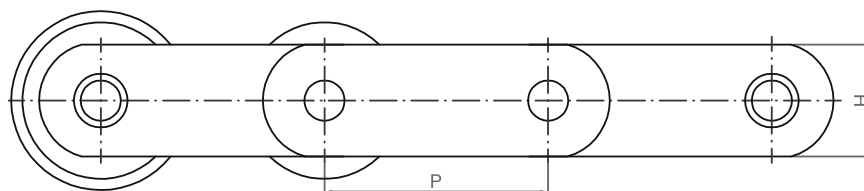

Referencia Reference Référence	Pasos estándar Standard pitches Pas standard	Ancho interior Inner width Largeur intérieure	Ø Casquillo Bush Douille	Ø Rodillos Rollers Rouleaux		Mallas Plates Mailloons		Eje Pin Axe		Carga de rotura Breaking load Charge rupture
				Grande Big Grand	Pestaña Flange Épaulé	Ancho Width Largeur	Espesor Thickness Épaisseur	Ø	Longitud Length Longueur	
				P*	B min	D6	D2	D5	H	
	mm	mm	mm	mm	mm	mm	mm	mm	mm	KN
Y-1	50,8 - 63,5 - 76,2 - 88,9 - 101,6 - 127,0 - 152,4	15	18	31,75	40,0	25	4	14	37	38
Y-2	76,2 - 88,9 - 101,6 - 127,0 - 152,4 - 177,8 - 203,2	19	24	47,5	60,0	40	5/4	19	45	100
Y-3	101,6 - 127,0 - 152,4 - 177,8 - 203,2 - 228,6	26	35	66,7	82,0	50	7/5	28	58	135
Y-4	152,4 - 177,8 - 203,2 - 254,0	38	40	88,9	114,0	60	10/8	32	84	258

* Otros pasos disponibles sobre pedido / Other pitches upon request / Pas différents sur demande

CADENAS TRANSPORTADORAS SERIE YT

Conveyor chains YT series

Chaînes de manutention série YT

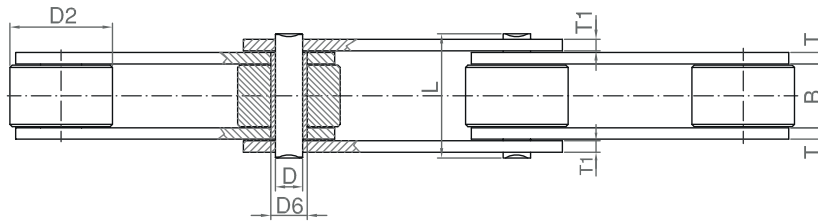
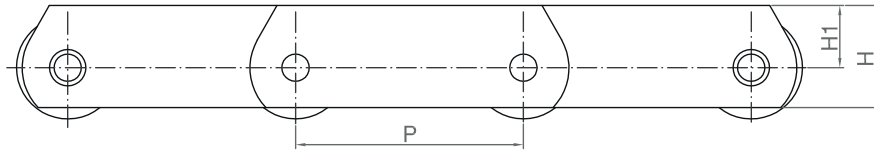

Referencia Reference Référence	Pasos estándar Standard pitches Pas standard	Ancho interior Inner width Largeur intérieure	Ø Casquillo Bush Douille	Ø Rodillos Rollers Rouleaux	Mallas Plates Maillons			Eje Pin Axe		Carga de rotura Breaking load Charge rupture
					Ancho Width Largeur	Altura Depth Hauteur	Espesor Thickness Épaisseur	Ø	Longitud Length Longueur	
					H	H1	T/T1	D	L max	
	P*	B min	D6	D2	H	H1	T/T1	D	L max	Q min
	mm	mm	mm	mm	mm	mm	mm	mm	mm	KN
YT-1	50,8 - 63,5 - 76,2 - 88,9 - 101,6 - 127,0 - 152,4	15	18	31,75	40	27	4	14	37	38
YT-2	76,2 - 88,9 - 101,6 - 127,0 - 152,4 - 177,8 - 203,2	19	24	47,5	50	30	5/4	19	45	100
YT-3	101,6 - 127,0 - 152,4 - 177,8 - 203,2 - 228,6 - 254,0	26	35	66,7	70	45	7/5	28	58	135
YT-4	152,4 - 177,8 - 203,2 - 254,0 - 304,8	38	40	88,9	90	60	10/8	32	84	258

* Otros pasos disponibles sobre pedido / Other pitches upon request / Pas différents sur demande

CADENAS TRANSPORTADORAS SERIE YC

Conveyor chains YC series

Chaînes de manutention série YC

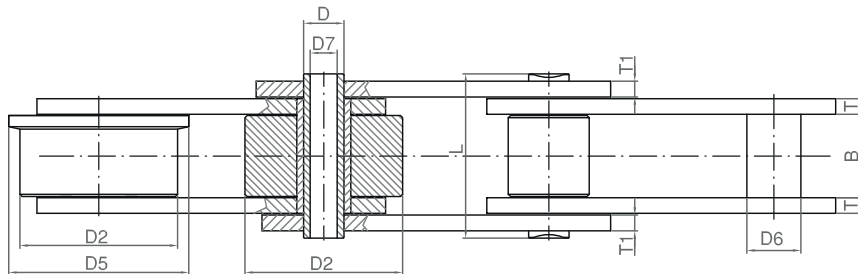
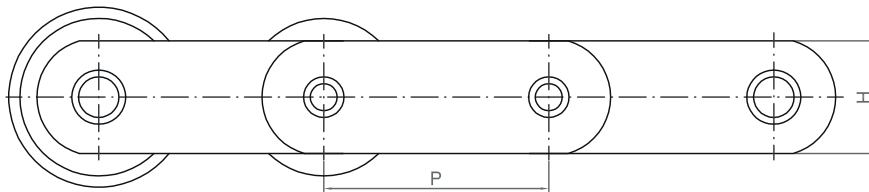

Referencia Reference Référence	Pasos estándar Standard pitches Pas standard	Ancho interior Inner width Largeur intérieure	Ø Casquillo Bush Douille	Ø Rodillos Rollers Rouleaux		Mallas Plates Maillons		Eje Pin Axe			Carga de rotura Breaking load Charge rupture
				Grande Big Grand	Pestaña Flange Epaulé	Ancho Width Largeur	Espesor Thickness Épaisseur	Ø Exterior Outer Extérieur	Ø Interior Inner Intérieur	Longitud Length Longueur	
	P*	B min	D6	D2	D5	H	T/T1	D	D7 min	L max	Q min
	mm	mm	mm	mm	mm	mm	mm	mm	mm	mm	KN
YC-1	50,8 - 63,5 - 76,2 - 88,9 - 101,6 - 127,0 - 152,4	15	18	31,75	40,0	25	4	14	10,2	37	38
YC-2	76,2 - 88,9 - 101,6 - 127,0 - 152,4 - 177,8 203,2	19	24	47,5	60,0	40	5/4	19	13,2	45	100
YC-3	101,6 - 127,0 - 152,4 - 177,8 - 203,2 - 228,6 254,0	26	35	66,7	82,0	50	7/5	28	20,2	58	135
YC-4	152,4 - 177,8 - 203,2 - 254,0 - 304,8	38	40	88,9	114,0	60	10/8	32	23,1	83	258

* Otros pasos disponibles sobre pedido / Other pitches upon request / Pas différents sur demande

CADENAS TRANSPORTADORAS NO ESTÁNDAR

Non standard chains series

Chaînes de manutention non standard



A Tipo / Type / Type

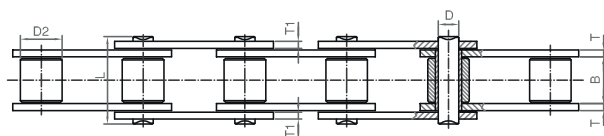
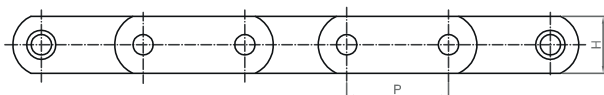

B Tipo / Type / Type

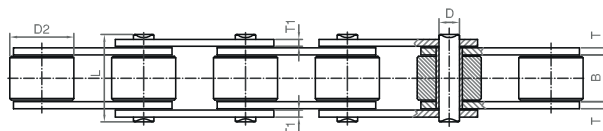
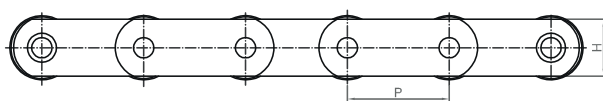

Cadenas transportadoras

Conveyor chains

Chaînes de manutention

Referencia Reference Référence	Paso Pitch Pas	Ancho interior Inner width Largeur intérieure	Ø Rodillo Roller Rouleau	Mallas Plates Mailloons		Eje Pin Axe		Carga de rotura Breaking load Charge rupture	Tipo Type Type
				Ancho Width Largeur	Espesor Thickness Épaisseur	Ø	Longitud Length Longueur		
				P*	B min	D2	H		
	mm	mm	mm	mm	mm		mm	KN	
70350LT003	35	14	14	18	3,5/2,5	7	31	37	A
70350LT004*	35	14	14	18	3	6	30,2	38,4	A
70350LT005	35	14	22	18	3,5/2,5	7	31	37	B
70350LT006	35	16	20	18	2,5	7	31	32	B
70350LG000**	35	16	14	18	2,5	7	31	32	A
70413LT000	41,3	12	16	22	2,5	9	27	40	A
70413LT001***	41,3	10	16	21	3	9	27	43,2	A
70413LT002	41,3	16	16	30	3	9	33	61	A
70413LG001**	41,3	16	16	21	3	9	33	43,2	A
70414LT001	41,4	22,23	17,9	20	3,4/2,7	8,22	39,3	47,3	A
70500LT000	50	15	31	25	4	10	36	75,4	B
70500LT004	50	11,5	25	18	2,5	5,7	26	24,5	B
70500LT006	50	11,5	25	20	3	8	28	43,2	B
70500LT010	50	15	31	23	3	10	33	48	B
70500LT013	50	16	25	18	2,5	6	31	27,2	B
70500LT014	50	16	20	25	3	7	33	37	A
70500LT015	50	25,4	25,4	40	5	14,63	54	161	A
70508LT012	50,8	16	25	20	3	7	33	37	B
70508LT016	50,8	17,02	15,88	20	4/3	8,28	36,1	54,4	A
70630LT006*	63	18	15	25	4	10	40	75,4	A

* Casquillo fijo / Fixed bush chain / Chaîne à douille

** Zincada / Zinc plated / Zinguée

*** Disponible zincada / Available in zinc plated / Disponible Zinguée

CADENAS TRANSPORTADORAS NO ESTÁNDAR

Non standard chains series

Chaînes de manutention non standard

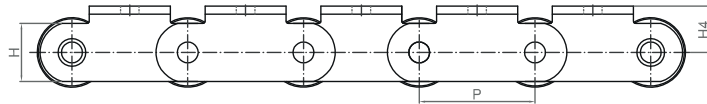

Aleta 1 lado
Attachment 1 side
Équerre 1 coté

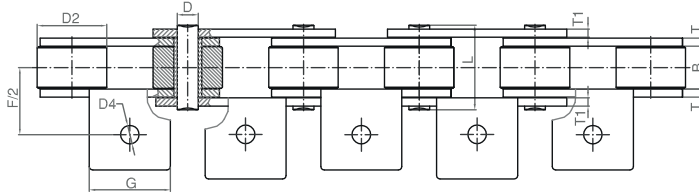

Con aleta 1 lado

With attachment 1 side

Avec équerre 1 coté

Referencia Reference Référence	Paso Pitch Pas	Ancho interior Inner width Largeur intérieure	Ø Rodillos Rollers Rouleaux	Mallas Plates Maillons		Eje Pin Axe		Aletas Attachment Équerres						Carga de rotura Breaking load Charge rupture	
				Ancho Width Largeur	Espesor Thickness Épaisseur	Ø	Longitud Length Longueur	Ancho Width Largeur	Altura Height Hauteur	Dist. entre taladros Dist. bet. holes Dist. entre trous	Nº taladros Holes Trous	Paso taladros Holes pitch Pas trous	Ø Taladros Holes Trous		Paso entre aletas Pitches bet. attachment Pas entre équerres
				H	T/T1	D	L max	G	H4	F/2		P1	D4		
mm	mm	mm	mm	mm	mm	mm	mm	mm	mm	mm	mm	mm	mm	KN	
70500AT001	50	11,5	25	15	3	5,7	28	41	25	24	1		6,5	2	24,5
70500AT002	50	11,5	25	18	2,5	5,7	26	46	24	22	1		6,5	2	24,5
70500AT003	50	15	31	25	4	10	36	35	20,5	27	1		10,5	2	70,4
70500AT006	50	15	31	23	3	10	33	30	28	31	1		10	1	47
70500AT007	50	11,5	25	18	2,5	5,7	26	46	24	22	1		6,5	1	24,5
70500AT009	50	15	31	23	3	10	33	60	35	31	1		10	2	47
70500AT017	50	12	15	15	2	6	25	30/40	20	25	1		8	2	21,8
70630AT000	63	18	30	20	3	7	35	25	20	32	1		9	6	37
70690AT000	69	12	25	19	2,5	7	27	60	25,5	25	1		7	2	36
70690AT001	69	12	25	19	2,5	7	27	60	25,5	25	1		7	1	36
70750AT000	75	22	30	40	6/8	14		50	36	48	1		12,5	4	147
70800AG000	80	20	50	35	5	12	47	50	26,25	37/54,5	2	17,5	8,25	6	108,6
71000AT001	100	25	45	35	6/5	14,6	55	50	2,5	54,5	1		12,5	2	158,4
71000AT010	100	28	35	50	6	18	59	60	40	53	2	25	11	1	244
71250AT009	125	25	45/55	35	6/5	14,6	55	60	35	45	2	30	11	1	158,4
71250AT011	125	32	60	40	6	15	64	65	12	55	1		11X23	1	169,9
71250AT016	125	25	45/55	35/100	6/5	14,6	55	75	30	47,5	2	50	13	1	158,4
72000AT001	200	37	60/75	45/100	6	16	69	120	6	55,5	2	90	13	1	193
72000AT003	200	37	60/75	45	6	16	69	120	40	51	2	90	11	1	193
72000AT004	200	37	60/75	50/100	6	18	69	120	6	55,5	2	90	13	1	244
72000AT006	200	33	75/90	60	10/8	22	77	120	40	57,5	2	90	11	1	365
72000AT007	200	37	60/75	45	6	16	75	120	40	51	2	90	11	1	193

CADENAS TRANSPORTADORAS NO ESTÁNDAR

Non standard chains series

Chaînes de manutention non standard

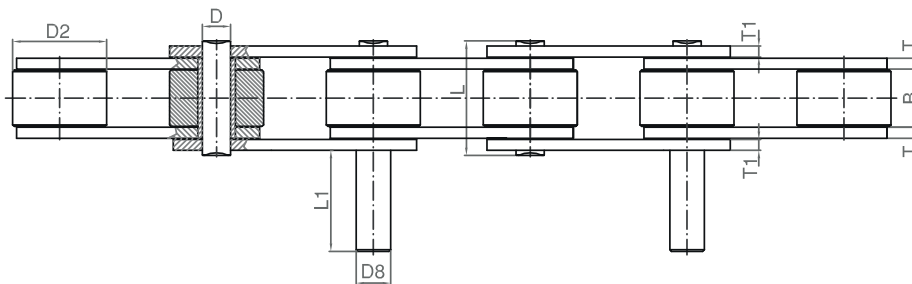
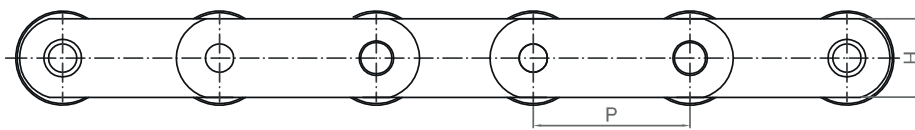

Con pivotes

With extended pins

Avec axes débordants

Referencia Reference Référence	Paso Pitch Pas	Ancho interior Inner width Largeur intérieure	Ø Rodillo Roller Rouleau	Mallas Plates Maillons		Eje Pin Axe		Pivote Extended pin Axe débordant		Carga de rotura Breaking load Charge rupture	Tipo Type Type
				Ancho Width Largeur	Espesor Thickness Épaisseur	Ø	Longitud Length Longueur	Ø	Longitud Length Longueur		
				H	T/T1	D	L max	D8	L1		
	P	B min	D2	mm	mm	mm	mm	mm	mm	KN	
70350PT000**	35	16	20	18	2,5	7	31	10	30	32	C/2
70350PT001*	35	16	20	18	2,5	7		10	30	32	T/P
70350PT002*	35	16	14	18	2,5	7	31	10	30	32	C/2
70350PT003	35	10	20	18	3/2,5	7	26	10	30	37	C/2
70350PT004	35	16	20	18	3	8	33	10	25	33,6	C/4
70350PG005****	35	16	20	26	2,5	10	31	10	35	52	C/2
70381PG001***	38,1	16	20	18	2,5	7		10	30	32	T/P
70413PT000	41,3	10	25	22	3	9	27	12	30	48	C/2
70413PT001	41,3	12	16	22	2,5	9		10	25	40	T/P
70413PT002	41,3	16	16	22	3	9	33	12	40	48	C/2
70413PT003	41,3	16	25	22	3	9	33	12	40	48	C/2
70413PT004	41,3	10	25	22	3	9		10	25	48	T/P
70413PG000***	41,3	10	25	22	3	9	27	12	40	48	C/2
70419PG000***	41,9	25,4	19,05	26	3	8	42,5	12,7	40	48,3	C/2

* Disponible zincada / Available in zinc plated / Disponible zinguée

** Disponible niquelada / Available in nickel plated / Disponible nickelée

*** Zincada / Zinc plated / Zinguée

**** Forma en "8" y zincada / Shape "8" plates & zinc plated / Maillon forme "8" & zinguée

CADENAS TRANSPORTADORAS NO ESTÁNDAR

Non standard chains series

Chaînes de manutention non standard

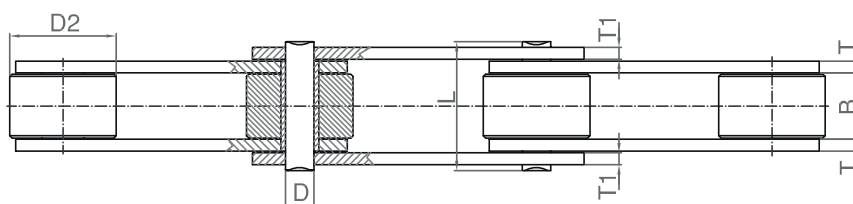
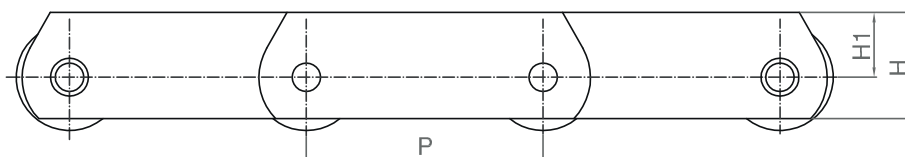

Cadenas transportadoras de mallas altas

Deep plates conveyor chains

Chaînes de manutention plaques élevées

Referencia Reference Référence	Paso Pitch Pas	Ancho interior Inner width Largeur intérieure	Ø Rodillo Roller Rouleau	Mallas Plates Maillons			Eje Pin Axe		Carga de rotura Breaking load Charge rupture
				Ancho Width Largeur	Altura Height Hauteur	Espesor Thickness Épaisseur	Ø	Longitud Length Longueur	
				H	H1	T/T1	D	L max	
	P	B min	D2	H	H1	T/T1	D	L max	Q min
	mm	mm	mm	mm	mm	mm	mm	mm	KN
70500LT002	50	15	31	30	17,5	4	10	36	75,4
70500LT007	50	11,5	18	17,5	10	2,5	5,7	25,5	24,5
70500LT011	50	11,5	25	25	16,5	2	5,7	24	24,5
70508LT011	50,8	15	31,75	40	27	4	14	37	57,6
70630LG000*	63	16	30	30	19	4	8,5	37	54,5

* Zincada / Zinc plated / Zinguée

CADENAS TRANSPORTADORAS NO ESTÁNDAR DE ACERO INOXIDABLE

Non standard stainless steel conveyor chains

Chaînes de manutention non standard acier inox



A Tipo/ Type/ Type

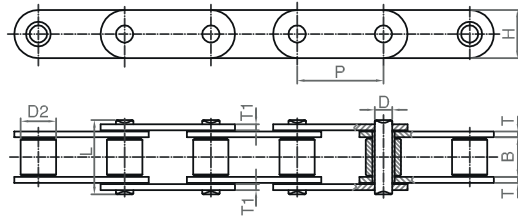

B Tipo/ Type/ Type

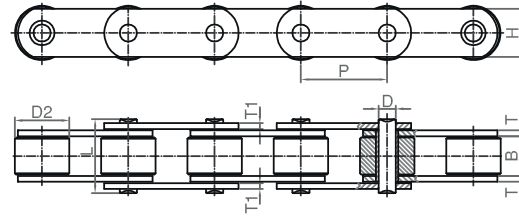

C Tipo/ Type/ Type

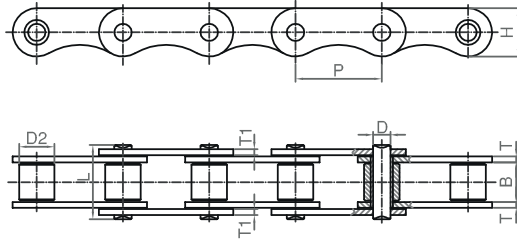

Referencia Reference Référence	Paso Pitch Pas	Ancho interior Inner width Largeur intérieure	Ø Rodillo Roller Rouleau	Mallas Plates Maillons		Eje Pin Axe		Carga de rotura Breaking load Charge rupture	Tipo Type Type
				Ancho Width Largeur	Espesor Thickness Épaisseur	Ø	Longitud Length Longueur		
				P	B min	D2	H		
mm	mm	mm	mm	mm	mm	mm	mm	KN	
70200LI001*	20	16	12	18	3	8	33	23,1	A
70254LI000	25,4	8	16	16	2	6	21	17,6	A
70350LI000**	35	14	22	18	2,5	8	29	19,3	B
70350LI003	35	16	14	18	2,5	8	31	19,3	A
70350LI004	35	14	14	18	2,5	8	29	19,3	A
70350LI005	35	16	20	18	2,5	8	29	19,3	B
70350LI008	35	15	22	19,5	2,5	8	29	23,4	C
70413LI000**	41,3	14	30	24	3	8	31	33	B
70413LI002	41,3	10	16	22	3	9	27	33	A
70413LI003	41,3	16	16	22	3	9	33	33	A
70414LI001	41,4	22,23	17,9	20	3,4/2,7	8,22	39,3	33	A
70500LI002	50	15	30	25	4	10	36	48,4	B
70500LI003	50	12	25	20	3	7,9	28	29,7	B
70600LI000	60	14	30	25	3	8	31	33	B
70600LI001	60	14	32	25	3	8	31	33	B
70630LI000**	63	16	25	19	3	8	33	26,4	B

* Cadena de casquillo fijo / Fixed bush chain / Chaîne à douilles

** Disponible con rodillo Delrin / Available with POM roller / Disponible avec rouleau POM

CADENAS TRANSPORTADORAS NO ESTÁNDAR DE ACERO INOXIDABLE

Non standard stainless steel conveyor chains

Chaînes de manutention non standard acier inox

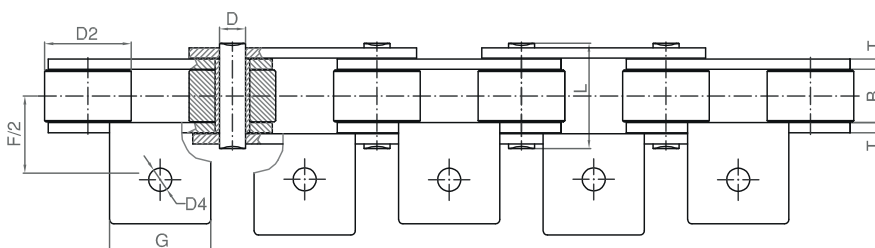
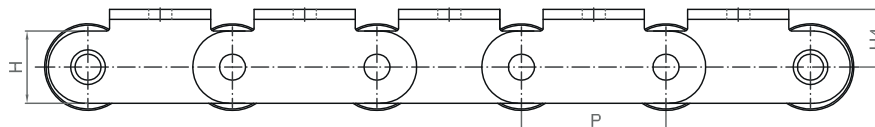

Cadenas transportadoras con aletas

Conveyor chains with attachments

Chaînes de manutention avec équerres

Referencia Reference Référence	Paso Pitch Pas	Ancho interior Inner width Largeur intérieur	Ø Rodillo Roller Rouleau	Mallas Plates Mailons		Eje Pin Axe		Aletas Attachment Équerres						Carga de rotura Breaking load Charge rupture
				Ancho Width Largeur	Espesor Thickness Épaisseur	Ø	Longitud Length Longueur	Ancho Width Largeur	Altura Height Hauteur	Dist. entre taladros Dist. bet. holes Dist. entre trous	Nº taladros Holes Trous	Ø Taladros Holes Trous	Paso entre aletas Pitches bet. attachment Pas entre équerres	
				H	T	D	L max	G	H4	F/2		D4		
70350AI006*	35	14	22	18	2,5	8	29	24	14	22,5	1	7	4	19,3
70350AI008*	35	14	22	18	2,5	8	29	24	14	22,5	1	7	2	19,3
70350AI010*	35	14	22	18	2,5	8	29	24	14	22,5	1	7	1	19,3
70413AI008*	41,3	14	30	24	3	8	31	30	18	35,5	1	8,5	4	33,2
70413AI010*	41,3	14	30	24	3	8	31	30	18	35,5	1	8,5	2	33,2
70413AI012*	41,3	14	30	24	3	8	31	30	18	35,5	1	8,5	1	33,2
70700AI000	70	14	30	20	3	8	31	60	13,75	29,5	1	10	6	30

* Disponible con rodillo Delrin / Available with POM roller / Disponible avec rouleau POM

CADENAS TRANSPORTADORAS NO ESTÁNDAR DE ACERO INOXIDABLE

Non standard stainless steel conveyor chains

Chaînes de manutention non standard acier inox

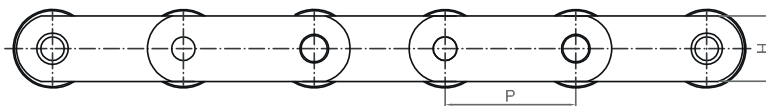

T/P Pivote en todos los pasos
Extended pin on every pitch
Axe déborant tous les pas

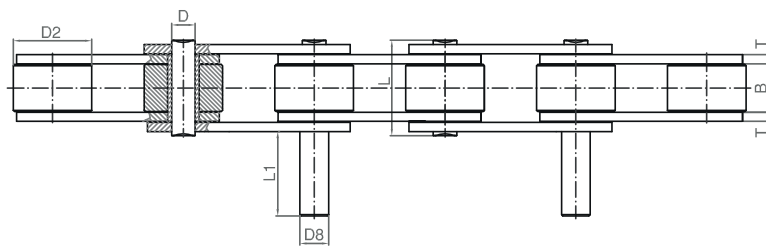

C/2 Pivote cada dos pasos
Extended pin on every 2 pitches
Axe déborant tous les 2 pas

Otras medidas sobre pedido
Other measures upon request
Autres mesures sur demande

Con pivotes

With extended pins

Avec axes débordants

Referencia Reference Référence	Paso Pitch Pas	Ancho interior Inner width Largeur intérieure	Ø Rodillo Roller Rouleau	Mallas Plates Maillons		Eje Pin Axe		Pivote Extended pin Axe débordant		Carga de rotura Breaking load Charge rupture	Tipo Type Type
				Ancho Width Largeur	Espesor Thickness Épaisseur	Ø	Longitud Length Longueur	Ø	Longitud Length Longueur		
				H	T	D	L max	D8	L1		
70350PI000	35	16	20	18	2,5	8	31	10	30	19,3	C/2
70350PI002	35	16	20	18	2,5	8		10	30	19,3	T/P
70350PI003	35	10	20	18	2,5	8	26	10	30	19,3	C/2
70413PI000	41,3	10	25	22	3	9	27	12	30	33	C/2
70413PI001	41,3	16	16	22	3	9	33	12	40	33	C/2
70500PI000	50	12	15	15	2,5	7		10	40	13,8	T/P
70750PI000	75	11	25	20	3	8		12	30	29,7	T/P

CADENAS DE CASQUILLO FIJO

Bush chains

Chaînes à douilles

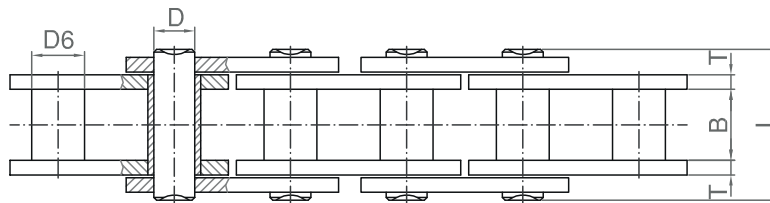
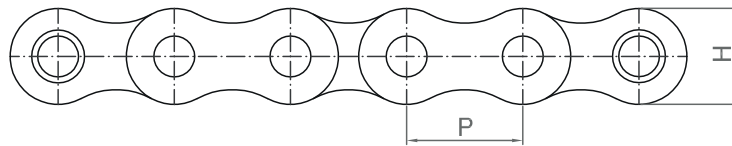

Referencia Reference Référence	Paso Pitch Pas	Ancho interior Inner width Largeur intérieur	Ø Casquillo Bush Douille	Eje Pin Axe		Mallas Plates Maillons		Carga de rotura Breaking load Charge rupture	Peso por metro Weight per meter Poids par mètre
				Ø	Longitud Length Longueur	Ancho Width Largeur	Espesor Thickness Épaisseur		
				D	L max	H	T		
	P	B min	D6	D	L max	H	T	Q min	q
	mm	mm	mm	mm	mm	mm	mm	KN	Kg/m
TM15	15	14	9	6	28	14	2	18	1,20
TM20	20	16	12	8	34	19	3	36	2,15
TM25	25	18	15	10	36	24	3	43	2,55
TM30	30	20	17	11	43	28	4	65	4,00
TM35	35	22	18	12	46	30	4	80	4,30
TM40	40	25	20	14	53	35	5	120	5,50
TM45	45	30	22	16	63	40	6	160	7,55
TM50	50	35	26	18	68	44	6	180	9,04
TM55	55	45	30	20	86	48	8	210	13,60
TM60	60	50	32	22	92	54	8	260	14,90
TM65	65	55	36	26	98	60	8	300	18,90
TM70	70	65	42	30	116	66	10	350	24,70
TM80	80	70	44	32	129	75	12	550	31,00
TM90	90	80	50	36	139	85	12	650	41,80
TM100	100	90	56	42	149	95	12	750	48,04

CADENAS TIPO REDLER

Scraper chains
Chaînes à racloirs

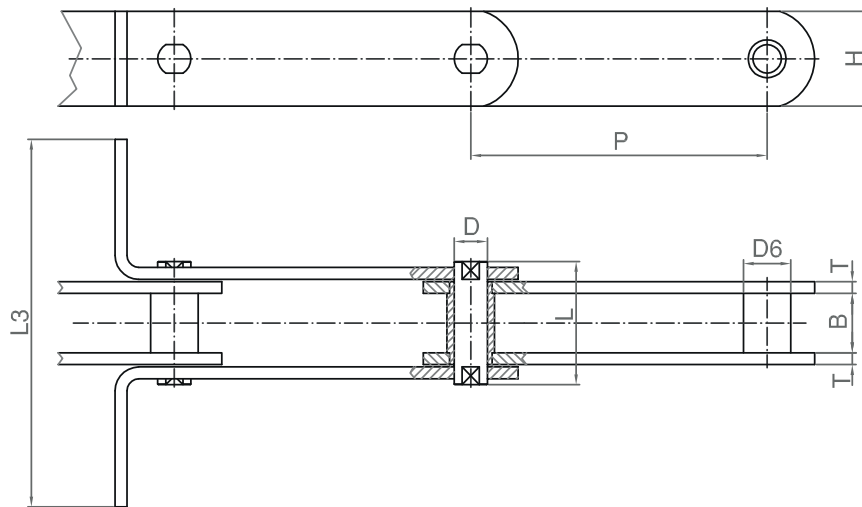

Paso Pitch Pas	Ancho interior Inner width Largeur intérieure	Ø Casquillo Bush Douille	Eje Pin Axe		Mallas Plates Maillons		Ancho pala Scraper Raclette	Carga de rotura Breaking load Charge rupture
			Ø	Longitud Length Longueur	Ancho Width Largeur	Espesor Thickness Épaisseur		
P	B min	D6	D	L max	H	T	L3 min	Q min
mm	mm	mm	mm	mm	mm	mm	mm	KN
100	20	17	12	43	35	4	140	55
125	20	17	12	43	35	4	140	55
100	22	18	12	44,5	30	4	140	63
125	22	18	12	44,5	30	4	140	63
100	25	20	14	52	40	5	140	90
125	25	20	14	52	40	5	180	90
150	25	20	14	52	40	5	180	90
100	30	22	16	61	40	6	180	112
125	30	22	16	61	40	6	180	112
150	30	22	16	61	40	6	180	112
200	30	22	16	61	40	6	180	112
125	35	26	18	67	50	6	200	140
150	35	26	18	67	50	6	240	140
200	35	26	18	67	50	6	240	140
150	45	30	20	85	50	8	280	180
200	45	30	20	85	50	8	280	180

* Consultar otras medidas / Other measures upon request / Autres mesures: nous consulter

Disponible remachada y desmontable 1 y 2 lados / Available riveted and detachable 1 & 2 sides /
Disponible rivetée et détachable 1 et 2 côtés

CADENAS DE ESLABONES FORJADOS

Forged link chains
Chaînes forgées

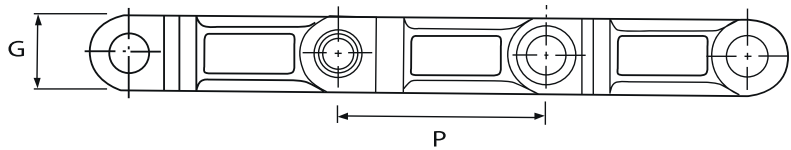
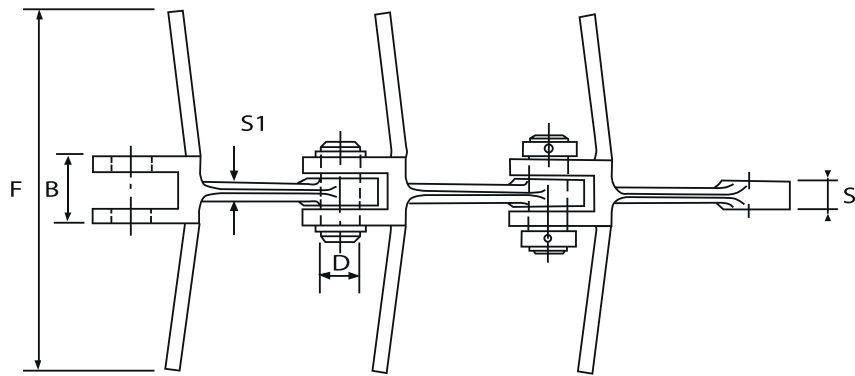

Referencia Reference Référence	Paso Pitch Pas	Ancho Width Largeur	Espesor Thickness Épaisseur	Espesor Thickness Épaisseur	Altura Height Hauteur	Ø Eje Pin Axe	Carga de rotura Breaking load Charge rupture
	P	B	S1	S	G	D	Q min
	mm	mm	mm	mm	mm	mm	KN
2FOR20	101,6	24	6	8	36	14	130
2FOR15	101,6	30	9	13	36	14	200
2FOR19	102	28	7,5	12	36	14	180
2FOR11	142	42	12	19	50	25	300
2FOR12	142	62	16	29	50	25	450
2FOR14	200	66	20	30	60	30	550

Material: 20MnCr5 Cementado / Case hardened / Cémenté

CADENAS GALLE

Gall chains
Chaînes galle

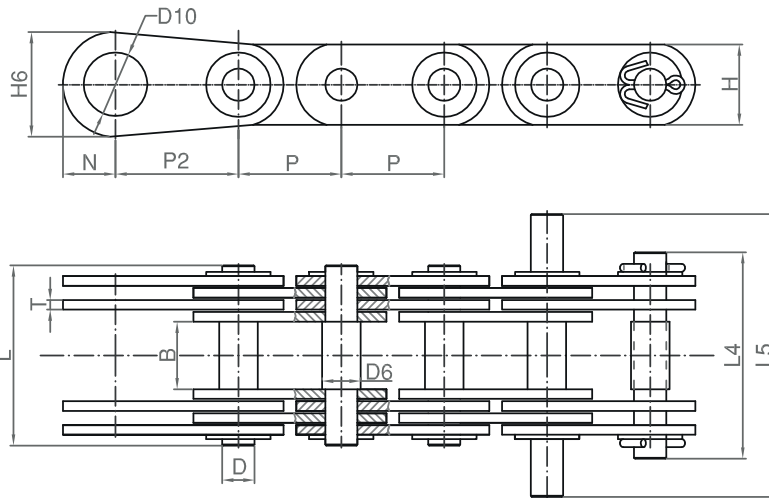

Paso Pitch Pas	Ancho interior Inner width Largeur intérieure	Eje Pin Axe		Longitud ejes Pins length Axe longueur			Mallas Plates Maillons	Terminal						Carga de rotura Breaking load Charge rupture	Peso por metro Weight per meter Poids par mètre
		D6	D	Remachado Riveted Rivé	Union C/L Mailon	Largo Long Longue		Por paso Per pitch Per pas	Ancho Width Largeur	Espesor Thickness Épaisseur	D10	H6	P2		
P	B min	mm	mm	mm	mm	mm		mm	mm	mm	mm	mm	mm	KN	Kg/m
10	8	4	3	17	19		2	8	1,5	6	16	15	10	8,8	0,40
15	12	5	4	24	26		2	12	2,0	9	18	20	11	15	0,70
20	15	8	6	27	32		2	15	2,0	10	20	25	12	30	1,10
25	18	10	8	35	41	67	2	18	3,0	12	25	30	15	50	1,75
30	20	11	9	50	57	87	4	21	3,0	14	30	40	18	100	3,40
35	22	12	10	52	60	92	4	26	3,0	16	35	45	21	130	4,50
40	25	14	12	57	65	101	4	30	3,0	18	40	50	24	150	4,70
45	30	17	14	62	69	107	4	35	3,0	22	45	55	27	175	6,40
50	35	22	18	89	96	140	4	38	4,5	26	50	60	30	250	10,60
55	40	24	21	107	114	162	4	40	6,0	32	55	65	33	310	15,50
60	45	26	23	113	119	170	4	45	6,0	36	60	70	36	360	18,00
70	50	32	28	147	156	212	6	55	6,0	40	70	85	42	670	33,50
80	60	36	32	158	170	232	6	60	6,0	50	85	100	51	700	38,20
90	70	40	36	183	199	265	6	70	7,0	60	100	120	60	1100	53,00
100	80	45	40	223	238	308	8	80	7,0	70	120	140	72	1550	76,60
110	90	50	45	235	250	326	8	90	7,0	80	140	160	84	1750	90,00
120	100	55	50	260	276	356	8	100	8,0	90	160	180	96	2200	112,00

CADENAS AÉREAS

Aerial chains
Chaînes aériennes



Tipo estándar
Standard type
Type standard

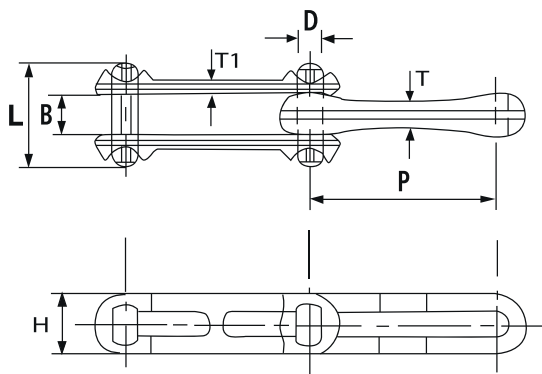

Tipo "X"
Type "X"
Type "X"

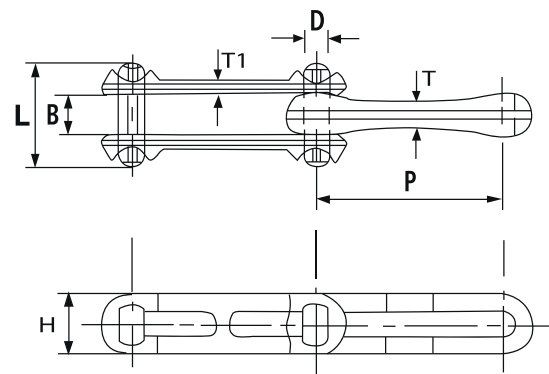

Forjadas

Forged
Forgées

Referencia Reference Référence	Paso real Real pitch Véritable pas	Ancho interior Inner width Largeur intérieure	Eje Pin Axe		Ancho mallas Plates width Largeur maillons		Carga de rotura Breaking load Charge rupture	Peso por metro Weight per meter Poids par mètre
			Ø	Longitud Length Longueur	Ancho Width Largeur	Espesor Thickness Épaisseur		
			P	B	D	L		
X348	76,2	18,8	12,7	44,0	28	13,0/10,4	110	3,3
X458	102,4	25,0	15,8	57,0	36	16,0/12,0	220	4,8
4"	101,6	25,0	15,8	57,0	36	16,0/12,0	220	4,8
CC100	100,8	25,0	15,8	57,0	36	16,0/12,0	220	4,8
468	102,4	40,9	19,1	81,0	48	29,0/16,0	320	11,2
X658	153,2	25,0	15,8	57,0	36	16,0/12,0	220	3,9
X678	153,2	32,5	22,2	77,0	51	20,6/18,0	380	10,0
698	153,2	39,1	28,4	98,0	64	25,4/22,2	605	17,0
160	160	32,5	22,2	77,0	51	20,6/18,0	380	10,0
998	229,4	39,1	28,4	98,0	64	25,4/22,2	605	13,4

CADENAS AÉREAS

Aerial chains
Chaînes aériennes

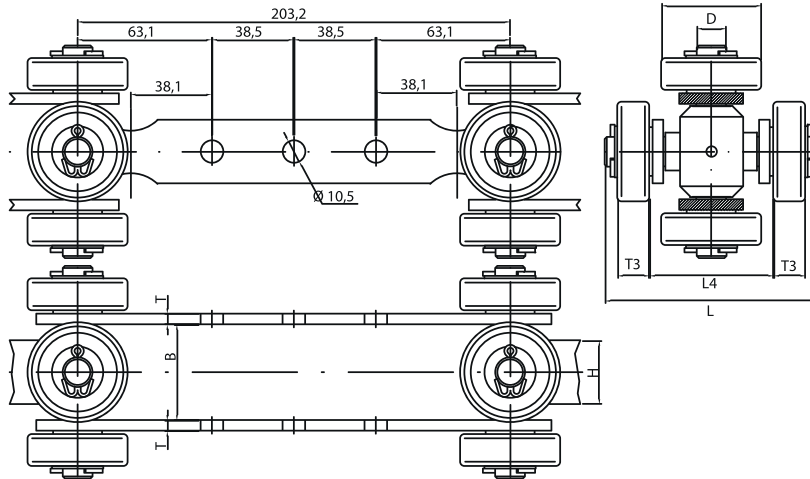

Con cruceta y rodamiento

With cross and bearing
Avec croix et roulement

Paso Pitch Pas	Ancho interior Inner width Largeur intérieur	Ø Eje Pin Axe	Ø Rodamiento Bearing Roulement	Ancho mallas Plates width Largeur maillons	Espesor mallas Plates thickness Épaisseur maillons	Longitud eje Pin length Longeur axe	Ancho rodamiento Bearing width Largeur roulement	Ancho entre rodamientos Width between bearings Largeur entre roulements
P	B	D	D2	H	T	L	T3	L4
mm	mm	mm	mm	mm	mm	mm	mm	mm
203,2	30	10	37	25	4	78	13	44
203,2	45	14	47	30	5	98	15	59



INDUSTRIAS YUK S.A.

Polígono "El Oliveral", Calle D parcelas 2 y 3, 46190 Ribarroja del Túrria (Valencia) Spain
+34 961 668 457 · yuk@yuk.es
www.yuk.es